

Training Manual for ANTAM Standard Code for Testing of Knapsack Misters-Cum-Dusters

Centre for Sustainable Agricultural Mechanization
United Nations Economic and Social Commission for Asia and the Pacific

December 2016

The Centre for Sustainable Agricultural Mechanization (CSAM), is a regional institution of the United Nations Economic and Social Commission for Asia and the Pacific (UNESCAP), based in Beijing, China. CSAM started operations in 2004, building on the achievements of the Regional Network for Agricultural Machinery (RNAM) and the United Nations Asian and Pacific Centre for Agricultural Engineering and Machinery (UNAPCAEM). CSAM serves the 62 members and associate members of UNESCAP.

The vision of CSAM is to achieve production gains, improved rural livelihood and poverty alleviation through sustainable agricultural mechanization for a more resilient, inclusive and sustainable Asia and the Pacific.

The Secretariat of the Asian and Pacific Network for Testing of Agricultural Machinery (ANTAM) is based at CSAM. CSAM is the executing agency of ANTAM. The ANTAM Secretariat assists and coordinates the operation of the network, and provides necessary logistical and administrative support.

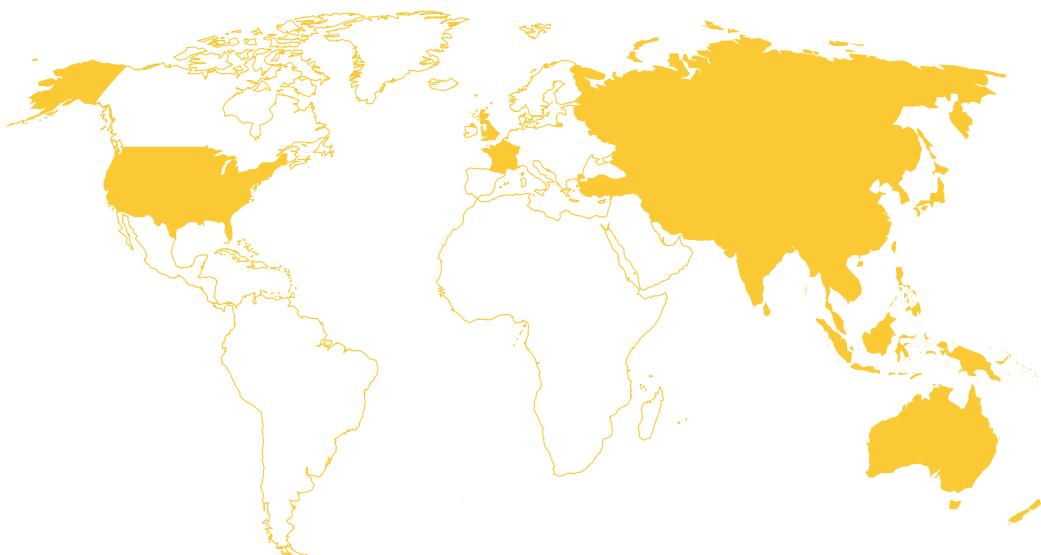

The shaded areas of the map indicate ESCAP members and associate members

The designations used and the presentation of the material in this publication do not imply the expression of any opinion on the part of the ESCAP Secretariat concerning the delimitation of its frontiers or boundaries. Any mention of firm names and commercial products do not imply the endorsement of ESCAP/CSAM.

**Training Manual for ANTAM Standard Code for
Testing of Knapsack Misters-Cum-Dusters**

Centre for Sustainable Agricultural Mechanization

The United Nations Economic and Social Commission for Asia and the Pacific

Forward

This training manual was prepared to support the 2nd Training of Trainers on ANTAM Test Codes organized in Nanjing, China, on 18-30 October, 2016 and part of the capacity building activities promoted by the United Nations Economic and Social Commission for Asia and the Pacific- Centre for Sustainable Agricultural Mechanization (UNESCAP- CSAM) in support of sustainable agricultural mechanization.

The ANTAM Codes for testing of Knapsack Misters- Cum- Dusters are developed and revised on a yearly basis by appointed members of Technical Working Groups. ANTAM Codes for Testing of Knapsack Misters- Cum- Dusters (002-2016) further refined tests such as Misting Discharge Rate, Air Velocity and Air Volume, Ground Deposition, Vertical Deposition, Misting Width, Droplet Size and Droplet Density to provide the operator with necessary information on parameters adjustments and avoid over use of chemicals.

The training manual is based on the first version of the ANTAM Training Manual on testing of Power Tillers published in 2015¹ and further developed based on the content of the second version of ANTAM Code for testing of Knapsack Misters- Cum- Dusters published in 2016.

The training manual will guide participating countries testing stations in the implementation of ANTAM Codes by providing pictures of needed equipment and detailed instructions on each test methodology. Kindly note, that where equipment provided by the facilitating testing station for the training was not in supply, slight modifications of ANTAM standard testing methodologies were made in order to demonstrate the procedure.

The 2nd Training of Trainers on ANTAM Test Codes is jointly organized by CSAM and the China Agricultural Machinery Testing Centre of the Ministry of Agriculture (CAMTC/ MoA). The training manual was prepared by Dr. Jean-Paul Douzals, Researcher at the French National Institute of Science and Technology for the Environment and Agriculture, CSAM and CAMTC. Valuable comments and suggestions were received from Mr. Zhang Xiaochen of CAMTC that assisted in the training preparation and tests demonstration. Mr. Wei Zhen contributed to the design of the cover page. Special thanks go to Ms. Han Xue and Ms. Bai Mengliang of CAMTC for facilitating communication.

Profound appreciation and deep gratitude are given to CAMTC for its generous financial support and the Jiangsu Testing Station for sparing no efforts in providing testing facilities.

The training manual is designed to guide member countries in the application of standards for testing of agricultural machinery. The Codes provide information only and do not constitute formal legal advice. The ANTAM Secretariat assumes no liability for actions undertaken in reliance on the information contained in the manual.

Mention or display of specific names, commercial products and services does not imply the endorsement of the United Nations.

¹ Available at: <http://www.antam-network.net/2016/2016/04/22/training-manual-for-antam-standard-codes-for-testing-of-power-tillers/>

The ANTAM Secretariat encourages the use and dissemination of this training manual for educational or non-profit purposes provided that appropriate acknowledgement of CSAM as the source is given. No use may be made of this training manual for resale or any other commercial purpose whatsoever without prior permission. All requests should be addressed to: antam@un-csam.org.

Content

A. GENERAL TEXTS	8
1. INTRODUCTION.....	8
1.1 SCOPE	8
1.2 REFERENCES.....	8
1.3 SPECIFICATIONS	8
1.4 SUBMISSION OF TEST SAMPLES.....	9
1.5 RUNNING-IN	9
1.6 SERVICING AND PRELIMINARY SETTING AFTER RUNNING-IN	9
1.7 REPAIRS AND ADJUSTMENTS DURING TESTS	10
1.8 DEFINITION AND VOCABULARY	10
B. CODES	11
1. Specifications.....	11
2. Materials	15
3. Operator and Service Manual	17
4. Submission of samples.....	18
5. Instrumentation, measuring tolerances and test rigs.....	19
6. Marking and Packing.....	26
7. Workmanship and finishing.....	26
8. Specifications for performance	28
9. Hose accelerated ageing test	30
9.1 Materials and instrumentation.....	30
9.2 Test procedure.....	30
9.3 Report.....	31
10. Chemical tank assembly test	32
10.1 Materials and instrumentation.....	32
10.2 Test procedure.....	32
10.3 Report.....	32
11. Strap drop test.....	33
11.1 Materials and instrumentation.....	33

11.2 Test procedure.....	34
11.3 Report.....	34
12. Straps absorbance test.....	35
12.1 Materials and instrumentation	35
12.2 Test procedure.....	35
12.3 Report.....	35
13. Blower air velocity	36
13.1 Materials and instrumentation.....	36
13.2 Test procedure.....	36
13.3 Report.....	38
14. Air volume test (ref ANSI/OPEI 172.5 Annex C).....	39
14.1 Materials and instrumentation.....	39
14.2 Test procedure.....	39
14.3 Report.....	39
15. Fan over-speed test	40
15.1 Materials and instrumentation.....	40
15.2 Test procedure.....	40
16. Misting discharge rate (full tank, various tank volumes) and residues	41
16.1 Materials and instrumentation.....	41
16.2 Test procedure (Full tank)	41
16.3 Report.....	42
16.4 Test procedure (intermediate levels of the tank) – maximum discharge rate.....	43
16.5 Report.....	43
17. Dusting discharge rate (full tank, various tank volumes) and residues	45
17.1 Materials and instrumentation.....	45
17.2 Test procedure (Full tank)	45
17.3 Report.....	46
17.4 Test procedure (intermediate levels of the tank – maximum discharge rate).....	47
17.5 Report	48
18. Misting or dusting range and width during ground deposition test	49
18.1 Objective	49
18.2 Materials and instrumentation.....	49

18.3 Test procedure (Full tank)	50
18.4 Report.....	51
19. Vertical deposition test (Mister only)	52
19.1 Materials and instrumentation.....	52
19.2 Test procedure (Full tank)	52
e. Number and collect all sponges and weigh the mass of water taking into consideration	53
19.3 Report.....	53
20. Measurement of droplet size and droplet density (Mister only)	54
20.1 Materials and instrumentation.....	54
20.2 Test procedure (Full tank)	54
20.3 Data Report.....	55
21. General Noise and ear level noise tests.....	57
21.1. Materials and instrumentation.....	57
21.2 Test procedure.....	57
21.3 Operator ear level noise measurement	58
22. Vibration test.....	60
22.1 Materials and instrumentation.....	60
22.2 Test procedure.....	60
22.3 Report.....	60
23. Reliability and endurance test.....	61
23.1 Materials and instrumentation.....	61
23.2 Test procedure Time to first failure test	61

DURATION OF TESTS

No.	Particulars	Duration
A	GENERAL TEXTS	
1	Introduction	
B	CODES	
1	Specifications	
2	Materials	
3	Operator And Service Manual	
4	Submission Of Samples	
5	Measuring Tolerances	
6	Marking And Packing	
7	Workmanship And Finishing	
8	Specification For Performance	
9	Hose Accelerated Ageing Test	72 h
10	Chemical Tank Assembly Test	
11	Strap Drop Test	
12	Strap Absorbance Test	
13	Blower Air Velocity And Air Volume Test	
14	Fan Over-Speed Test	
15	Misting Discharge Rate (Full Tank And Various Tank Volumes) And Residues	
16	Dusting Discharge Rate (Full Tank And Various Tank Volumes) And Residues	
17	Misting Or Dusting Range And Width During Ground Deposition Test	
18	Vertical Deposition Test	
19	Droplet Size And Density Test	
20	General Noise And Ear Level Noise Tests	
21	Vibration Test	
22	Reliability And Endurance Test	50-100 h 120 h

A. GENERAL TEXTS

1. INTRODUCTION

1.1 SCOPE

This test code covers the terminology, general guidelines and tests to be conducted on powered knapsack mister cum duster fitted with a small < 4.5 kW gasoline engine coupled with a centrifugal fan. The code covers methodology for checking on machine specifications, materials, noise, vibration, safety and inspection of components and applications, labels, packing, transportation and storage. This code also prescribes the performance and other requirements of powered knapsack type pneumatic mister cum duster for spraying chemicals in liquid form and convertible into duster for dusting the chemicals in powder form.

1.2 REFERENCES

The Standards listed in Annex A contain provisions which through reference in this text, constitute provision of this draft standard incorporating existing international standards (ISO) and national standards practiced by China and India. The selection of publications, the editions indicated were provided by the various national representatives on test standards. Typical engine power for powered knapsack mister cum duster is 3 kW, current relevant standards for 3 kW and below small gasoline engines in the Chinese JB/T 5135-1991 (for engine less than 30 kW) and the Indian IS: 7347-1974 (for engine less than 20 kW) are referred. The ISO 8178-4:2007 standard is also referred. Specific references selected are the Chinese JB/T 7723-2014 and the Indian IS: 7593.1-1986. All selected standards are subjected to revision and considered recent as per documents provided. There is the possibility of applying the most recent editions of the standards indicated. All documents provided from the various national standards agency are copyrighted.

1.3 SPECIFICATIONS

1.3.1 Specification(s) - Manufacturer/applicant shall complete the specification sheet given in Annex B-1 for the power operated knapsack mister cum duster along with schematic drawing of the equipment and any other information required by the testing authority to carry out the tests. The manufacturer/applicant should also supply technical literature such as operation and maintenance manual, service manual and parts catalogue.

1.3.2 Material - The material for construction of different components of powered knapsack mister cum duster except gasoline engine is given in B-2 Annex B. All components coming in contact with the chemicals shall be of good quality chemical resistant materials.

Note: The specification data sheet for tests of powered knapsack mister cum duster for China JB/T 7723.1-2005, JB/T 7723.2-2005 and India IS 7593 (Part 1)-1986 has been referred.

1.3.3 Manual - Manufacturer can prepare operators and service manual separately or as a single document. But operational and maintenance manual should contain complete list of regular and optional parts, method of converting the mister into duster, instruction on adjustments, assembly and disassembly

for cleaning and routine inspection and replacement of parts and safety precautions to be taken during operation and handling. Manuals shall comply with the ISO 3600: 1998 or IS 8132:1999 standards and contain information on: main technical details of engine, rated speed, tank capacity, misting/dusting rate at recommended pressure, recommended pressure range, horizontal spray range, starting and stopping instructions, safety, common faults and repairs, safe chemical handling, cleaning, maintenance, storage, forbidden chemical/liquid to be used, manufacturer and supplier contact details.

1.4 SUBMISSION OF TEST SAMPLES

The powered knapsack mister cum duster, under production, should be selected by the manufacturer from the production line, complete with its standard accessories and in a condition as generally offered for sale. The power operated knapsack mister cum duster shall be new and should not be given any special treatment or preparation for test. At least 5 units of current year production, new and unused qualified machine are to be submitted. An additional unit of a similar machine with the engine removed is to be supplied.

1.5 RUNNING-IN

1.5.1 The manufacturer/applicant shall run-in the powered knapsack mister cum duster before the test, under his responsibility and in accordance with his usual instructions. The running-in shall be carried out in collaboration with the testing authority. If this procedure is impracticable due to the powered knapsack mister cum duster being an imported model, the testing authority may itself run-in the powered knapsack mister cum duster in accordance with the procedure prescribed or agreed to with the manufacturer/applicant.

1.5.2 The place and duration of the running-in shall be reported in the pro-forma given in Annex C-2.

1.6 SERVICING AND PRELIMINARY SETTING AFTER RUNNING-IN

1.6.1 Servicing - After completion of running-in, servicing and preliminary settings should be done according to the printed literature supplied by the manufacturer/applicant. The following may be carried out, wherever applicable:

- a) Change of the engine oil;
- b) Change of oil and fuel filters (if required);
- c) Greasing/oiling of all the lubricating points;
- d) Tightening the nuts and bolts;
- e) Checking and adjustment of safety devices, if any;
- f) Any other checking or adjustment recommended by the manufacturer after the running-in period, and included in the printed literature of the powered knapsack mister cum duster.

1.6.2 Preliminary setting - The manufacturer/applicant may make adjustments in any other adjustments during the period the powered knapsack mister cum duster is prepared for tests.

These adjustments should conform to the values specified by the manufacturer/applicant for agricultural use in the printed literature/specification sheet. No adjustment shall be made, unless it is recommended in the literature. All the parts replaced shall be reported in the test report.

1.7 REPAIRS AND ADJUSTMENTS DURING TESTS

1.7.1 Repairs - All repairs made during the tests shall be reported, together with comments on any practical defects or shortcomings in Annex C-2. This shall not include those maintenance jobs and adjustments which are performed in conformity with the manufacturer's recommendations.

1.8 DEFINITION AND VOCABULARY

A portable mister cum duster is commonly used to apply crop protection products or fertilizers under liquids, dust, powders or micro granules forms. Compared to a traditional knapsack sprayer, the misting and dusting is achieved with the help of air assistance provided by a blower.

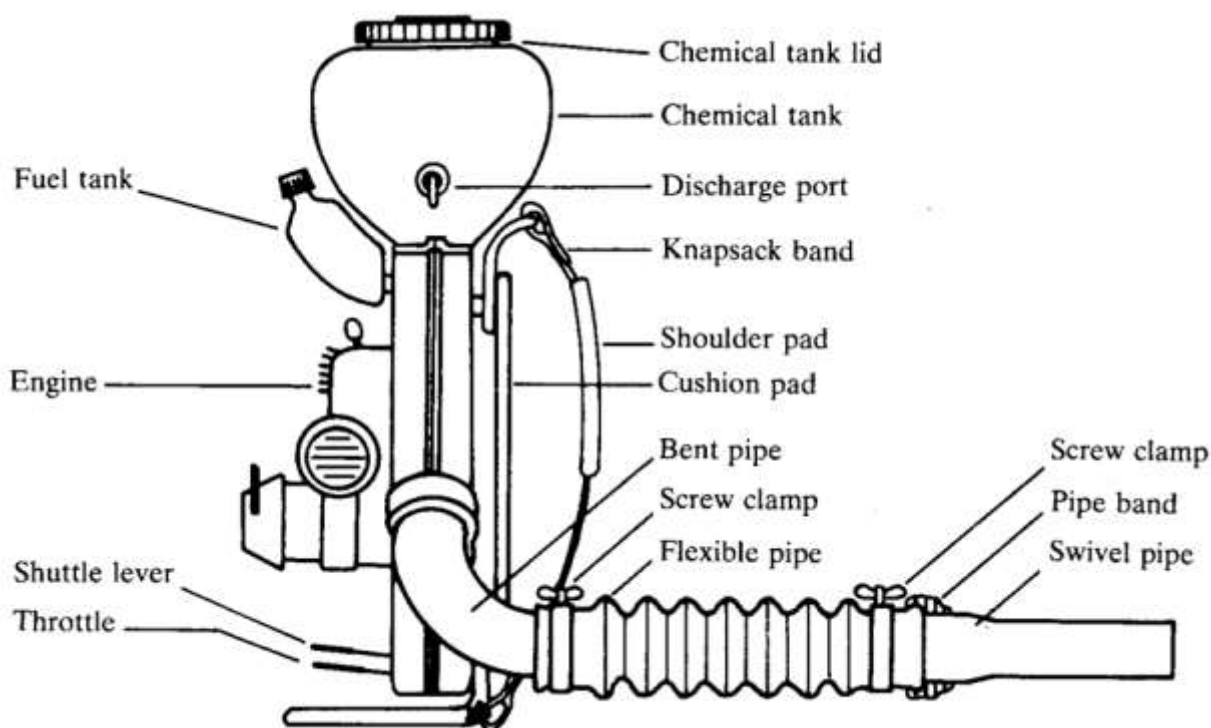

B. CODES

1. Specifications

Refers to Annex B (B-1 and B-2) – ANTAM Test code.

Fill in the following table:

1.0	GENERAL	PLEASE INDICATE
1.1	Name & address of manufacturer <i>(If more than one give details of manufactures. Separate sheets may be used)</i>	
1.2	Name and address of the applicant for test	
1.3	Make/Type/Model	
1.4	Serial number	
1.5	Year of manufacture	
2.0	ENGINE <i>(No test necessary if a certified test report is provided by the manufacturer (according to either one of the following standard: IS 7374-1974, JB/T 5135.1 or ISO 8178.4-2007)</i> <i>(If no engine test certification provided the equipment might be rejected)</i>	
2.1	Make/Type/Model/Country	
2.2	Serial number	
2.3	Engine (manufacturer's recommended settings) - Rated power, kW - Maximum torque, Nm - Rated speed at no load, rpm - Low idle speed, rpm - Speed at max. torque, rpm - Specific fuels consumption, g/ kWhr	

	- Specific oil consumption, g/ kWhr	
2.4	Type of fuel used (<i>octane number</i>)	
2.5	Capacity of fuel tank, l	
2.6	Presence of strainer at engine tank inlet, yes/no	
2.7	Type of fuel filter	
2.22	Starting system: - Type - Aids for cold starting, if any - Any other device provided for easy starting	
2.23	Noise level at maximum speed, dB(A)	
3.0	FRAME	
	Material of construction	
	Size (<i>Width x height x length</i>), mm	
4.0	TANK (<i>Please indicate each for misting and dusting in case of two separate tanks</i>)	
	Shape (<i>Trapezoidal/Cylindrical/ Any other</i>)	
	Size (<i>In case of Trapezoidal : Width x height x depth, In case of cylindrical: Diameter x length</i>), mm	
	Capacity, litre	
	Material of construction	
	Size of liquid filling hole, mm	
	Strainer or filter Mesh (< 2 mm)	
	Marking on the tank, if any	
5.0	BACK REST	
	Size (<i>Width x height x thickness</i>) , mm	
	Material	

6.0	STRAP	
	Material of strap	
	Material of strap buckle	
	Width and thickness of strap, mm	
	Minimum and Maximum strap length can be used, mm	
7.0	MISTING DUCT	
	Type of misting duct	
	Misting duct internal diameter, mm	
	Misting duct discharge at recommended pressure, ml/min	
	Misting range (m)	
8.0	BLOWER	
	Fan type : Fully enclosed / partially enclosed	
	Fan blade type : Forward bent / radial / backward bent	
9.0	DUSTING or MICR GRANULES	
	Dusting width, m	
	Dusting discharge rate (horizontal), kg/min	
10.0	TOTAL MASS (<i>without liquid/dust</i>), kg	
11	DETAILS OF AGITATING DEVICE PROVIDED (if any)	
12	LIST OF STANDARD ACCESSORIES/PARTS PROVIDED WITH EQUIPMENT (provide as annex)	
13	PUBLICATIONS	

	Operator's manual Service Manual Parts catalogue Safety Precautions	
--	--	--

2. Materials

Refers to Annex B-2 of ANTAM test code

No.	Component	Material	Please Indicate
1.	Tank	Fibre glass reinforced plastics Plastics HDPE	
2.	Lid or cap	Fibre glass reinforced plastics Plastics HDPE	
3.	Frame	Mild steel Engineering plastics	
4.	Impeller	Mild steel Galvanized plain steel Aluminium alloy Fibre glass reinforced plastics Plastics	
5.	Casing	Mild steel Galvanized plain steel Aluminium alloy Fibre glass reinforced plastics Plastics	
6.	Air bent outlet	Galvanized plain steel Plastics	
7.	Air hose	Rubber, fabric braided Rubber, synthetic Plastics	
8.	Strap	Leather, vegetable tanned Woven web cotton Yarn, synthetic	
9.	Strap buckle	Mild steel Galvanized plain steel Aluminium Engineering Plastic	
10.	Cushion	Foam rubber Foam plastics	
11.	Gasket	Rubber, synthetic PVC Leather Fibre	
12.	Air pressure regulating device	Brass Plastics	
13.	Air pressure pipe	Plastics	
14.	Liquid or dust	Brass	

	regulating device	Plastics	
15.	Hose clip	Mild steel Galvanized plain steel	
16.	Air duct (misting or dusting)	Stainless steel Plastic	
17.	Valve assembly	Brass Stainless steel Plastics	
18.	Pipe for agitator	Galvanized iron Brass Polyvinyl chloride (PVC)	

3. Operator and Service Manual

	Yes	No
Operator manual		
Service manual		
Main technical details of the engine		
Engine rated speed		
Tank capacity		
Misting and dusting rate adjustment		
Misting and dusting range		
Starting and stopping instructions		
Safety during operation		
Common defaults and repairs		
Safe chemical handling		
Cleaning		
Maintenance		
Storage		
Forbidden chemical/liquids		
Manufacturer/supplier contact details		
List of regular and optional parts		
Method to convert mister into duster		
Remarks :		

4. Submission of samples

Pro-forma For Submission, Running-In and Repairs

1. Name of the manufacturer:
2. Address:
3. Submitted for test by :
4. Sample model and serial number:

Sample 1:

Sample 2:

Sample 3:

Sample 4:

Sample 5:

Sample 6 (additional unit without engine):



- 5.
6. Date of manufacture:
7. Place of running-in:
8. Duration and schedule of running in:
9. Repairs and adjustments made during running-In:
10. Received by: date:

11. Signatures (manufacturer)

12. Signature (test center):

List of spare parts provided :

5. Instrumentation, measuring tolerances and test rigs

No	Test items	Measuring device (example)	Accuracy	Notes
1	Rotational speed, rev/min		± 0.5	Tachometer
2	Anemometer		± 0.1	Portable anemometer or Pitot sensor
3	Time variation, s		± 1	Digital stopwatch

4	Noise variation, dB (A)		± 0.5	Sound level meter
5	Vibration, %		± 10	Accelerometer
6	Weight variation, kg		± 0.05	Weighing balance of sufficient accuracy

7	Weight variation, g		±0.05	Weighing balance of sufficient accuracy
8	Pressure, % FS		+ 1 (< 10 kPa)	Pressure, % FS
9	Wind speed, m s ⁻¹		± 5% FS	Anemometer
10	Temperature, °C		± 1 °C	Thermometer

11	Relative Humidity, % FS		$\pm 1\%$	Hygrometer
12	Paint layer thickness		$2 \mu\text{m} \pm 3\%$	Digital coating thickness gauge
13	Distance, mm		0.1 mm	Vernier caliper,
14	Distance, m		0.01m	Mesuring tape, 0.01m

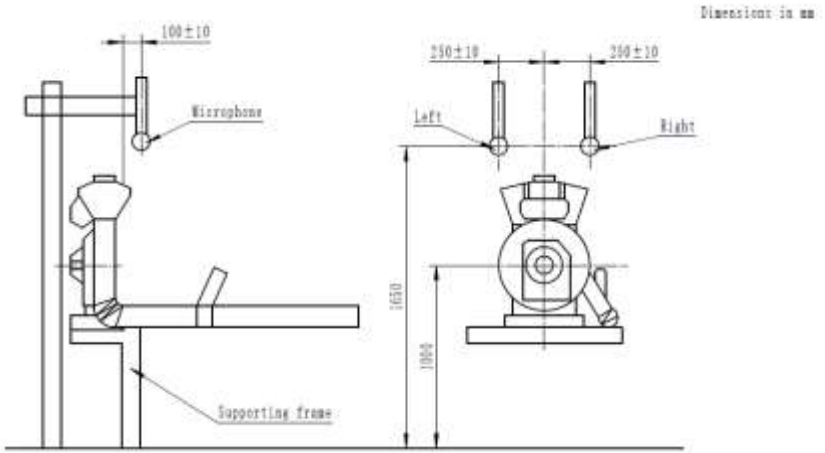
15	Strength of material testing (N)		1N	
16	Test rig used to fix the mister cum duster for blower test, misting or dusting range and noise test			

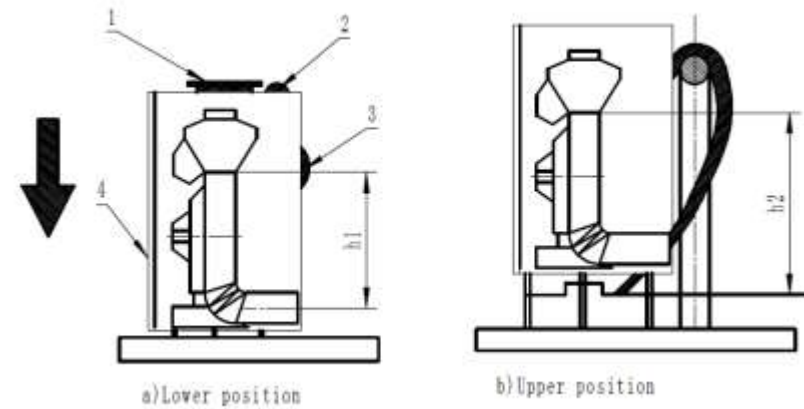
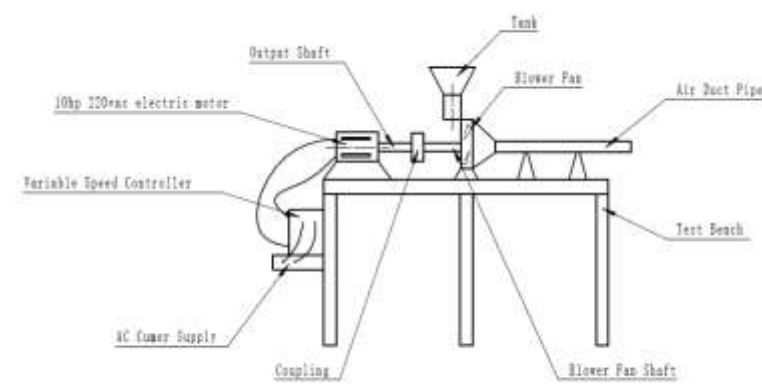
<p>17</p>	<p>Test rig used for the strap test</p>	 <p>a) Lower position b) Upper position</p> <p>Key 1 mister cum duster 2 straps 3 restraining bar 4 guides height</p> <p>$h2-h1=300mm$</p>
	<p>Test rig for fan overspeed test</p>	 <p>10hp 200rpm electric motor Variable Speed Controller AC fume supply Output shaft Coupling Blower Fan shaft Blower Fan Air Duct Pipe Test Bench Tank</p> <p>Figure Test rig for over-speed mister-cum-duster test</p>

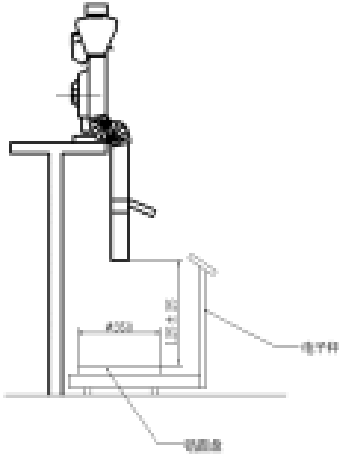
	Aging box		$\pm 1\text{ }^{\circ}\text{C}$	Stove
	<p>Test rig for blower test acc. ANSI 172.5</p> <p>Balance 5kg range</p>		$\pm 10\text{g}$	

6. Marking and Packing

Each mister-cum-duster shall be marked with the following particulars:

Marking	Comment	Present
Manufacturer's name or registered trade-mark		
Tank capacity		
Production code and serial number		
Engine certification label		
Type of fuel used		
Maximum blower speed (RPM)		
Safety labels		
Control device labels <i>(In the control device or nearby location, there shall have clear labels², its contents should reflect the basic characteristics of the control device).</i>		
Any other ANTAM approved Asia Pacific member countries national certification label <i>(The use of the certification label is governed by the approval of the ANTAM secretariat).</i>		
Packing <i>(Each unit shall be first packed in a polyethylene bag and then in a wooden case or carton package of sufficient strength to avoid damage in transit. Spare Parts - Spare parts separately packed for each mister-cum duster according to the number required shall be provided).</i>		

7. Workmanship and finishing

All the components of the unit shall be free from burrs, pits and other visual defects which may be detrimental for their use. The exposed metallic parts shall have a protective coating to prevent surface deterioration. The paint quality shall comply with the following: (Source: Chinese JB/T 5673.)

Instrumentation: See Section 5 item 12, Paint layer thickness meter

Method : Randomly select 5 spots and measure, compute the average of the 5 spots

Criteria	Yes	No
The paint coating surface shall be flat, smooth, uniform, without pinhole, pitting, there shall not have any painting defects.		
The total thickness of the paint coating shall not be less than 40 μm		

² Signs or engraved letters or signs are also accepted

Remarks :

8. Specifications for performance

Verification of the information provided in Annex B-1.

Instrumentation : Please refer to items listed in Section 5

Criteria	Performance level	Method	Compliance (Yes/No)
Tank	Filling hole of min. 90 mm	Measure	
	Cap or lid covering the tank hole and water tight	Check	
	Tank of min. 10 L capacity	Measure	
	Easy interchangeable tank from misting to dusting	Check	
	Less than 5% variation between measured and declared tank volume	Measure	
	No leakage/buckle when the tank is filled at full capacity	Check	
Strainer	Mesh size shall be between 0.5 mm to 2 mm	Measure	
Leakages	No leakage/buckle shall occur on connected hoses air pressure hose when the tank is filled at full capacity	Check	
Impeller	The impeller of the fan shall be dynamically balanced at its rated speed. The impeller shall not touch casing at any point.	Check	
Blower housing	The internal and external blower housing surface shall be smooth, without dents or depressions, cracks and defects. Testing is by observation and manual hand feeling method.	Check	
Air bent outlet	An air bent outlet may be provided. If provided, shall be connected with fan casing outlet, air hose and air pressure regulating device.	Check	
Flow regulator	A device to regulate the flow of the liquid or dusting powder shall be provided.	Check	
Straps	2 straps shall be provided	Check	
	Not less than 800 mm length, 38 mm width	Measure	
	Strap cushion of min 40 mm width and 20 mm thick	Measure	
	Back rest with cushion of 200 x 200 x 20 mm	Measure	
	Cushions made of cotton, canvas, resin, or plastic coated parts	Check	
	1 adjustable single strap provided to carry the mister cum duster	Check	
	1 double shoulder strap shall be designed so that pressure is evenly distributed on both shoulders of the operator. The design of the double shoulder strap shall prevent slipping in any direction.	Check	
	All double shoulder straps shall be equipped with a quick-release mechanism positioned either at the connection between the mister cum duster and strap or between the strap and operator. Either the strap or the use of the quick-release mechanism shall ensure that the mister cum duster can be released quickly from the operator in the event of emergency. If a quick-release mechanism is provided, it shall be possible to open it under load and release the machine using only one hand.	Check	
	Each shoulder strap shall have a load bearing part of at	Measure	

	least 200 ± 10 mm of a minimum comfort width of 50 mm. The load shall be distributed over the whole width		
	If the load bearing area area is formed by a pad, this shall not slip from its position unintentionally.	Check	

Engine	The gasoline engine used should comply with JB/T 5135.1, IS:7347-1974 or ISO 8178-4:2007. (Without governor)	Check	
	The gasoline engine should follow the starting procedures as listed in the operation manual under normal temperature conditions	Check	
	Recoil rope starting used for starting gasoline engine should be able to start the engine at least once in three attempts within 30 s.	Check	
	All engine control components shall be normal without restriction, easy to control with the maximum rated engine achieved at the highest setting. It shall also allow the engine shut off at the lowest level setting.	Check	
	A separate manual button/switch for stopping the engine shall be provided for hand lever operated idle speed set at the lowest level position. The fuel and chemical discharge controls shall be in easy access of the operator	Check	
	The exhaust outlet of the engine shall be so positioned that the smoke does not directly affect the operator or crop, At the option of the purchaser, a guard shall be provided on or near the exhaust pipe for the protection of the operator.	Check	
	Dangerous parts of the gasoline engine: recoil rope starter, exhaust (silencer), inlet of blower shall be fitted with protective cover. The rotating parts such as the entrance of fan, starting wheel, etc. shall be equipped with protective cover with proper strength. The muffler and other high-temperature components shall be equipped with protective device to avoid empyrosis. If dimensions of the protective shield are not sufficient because of the structure, warning signs shall be set up, and noted in the manual.	Check	
	Engine speed	Check if information available (engine certificate)	
	Engine power at the crankshaft		
	Indicated horse power		
	Fuel consumption		
	Specific fuel consumption		
Full throttle			
Gasoline engine			

9. Hose accelerated ageing test

9.1 Materials and instrumentation

Equipment	
Stove	Traction for test bench and sensor
	

- a. This test is destructive and the availability of 2 spare hoses shall be verified prior testing.
- b. It requires an elongation test bench with according dimensions and strength such as a rubber hose sample can be tested.
- c. Attention shall be paid to safety when operating the test

9.2 Test procedure

- a. Prepare two identical samples from rubber hoses provided with spare parts. Samples shall have a dimension adapted to the tensile test device (ex : 20 cm x 3cm).
- b. Measure the maximum tensile strength (Sf1) and the maximum elongation at breakage for sample 1 (E1).
- c. Place the sample 2 in a stove at 70 °C ± 1 for a period of 72 hours (3 days) for accelerated ageing.
- d. Measure the maximum tensile strength (Sf2) and the maximum elongation at breakage for the sample 2 (E2).

Calculations and criteria:

Variation in maximal tensile strength: $\Delta S = 100 \times (Sf2 - Sf1) / Sf1$ **max. ± 25%**

Variation in maximal elongation: $\Delta E = 100 \times (E2 - E1) / E1$ **min -10%; max + 30%**

9.3 Report

Samples		Data	Material or reference if present
Before test	Length, cm		
	Hose 1, Li1		
	Hose 2, Li2		
After test	Elongation, cm		
	Hose 1, E1		
	Hose 2, E2 (aged)		
	Tensile strength, N		
	Hose 1, Sf1		
	Hose 2, Sf2 (aged)		
Variation	Elongation, %		
	Tensile strength, %		

10. Chemical tank assembly test

10.1 Materials and instrumentation

- a. This test is non-destructive and is operated on one complete mister.
- b. Attention shall be paid to safety when operating the test



10.2 Test procedure

- a. Conceal the end of the pressure hose,
- b. Place the mister cum duster upside down and immerse at the first half of the tank level
- c. Apply an air pressure of 0.01 MPa (0.1 bar) at the liquid discharge hose into the chemical tank for 1 minute.
- d. The tank, connected hoses and air pressure hose shall not show any sign of leakage and shall not buckle.

10.3 Report

Record result in the main summary test report

11. Strap drop test

11.1 Materials and instrumentation

Equipment		
Strap drop test bench and sensor		
		

This test is normally non-destructive. It requires a support for strap drop test as proposed on Figure 11a.

WARNING: This test has an element of risk. All personnel shall either be kept out of the test area or otherwise protected from hazards such as parts displaced from the mister cum duster on test.

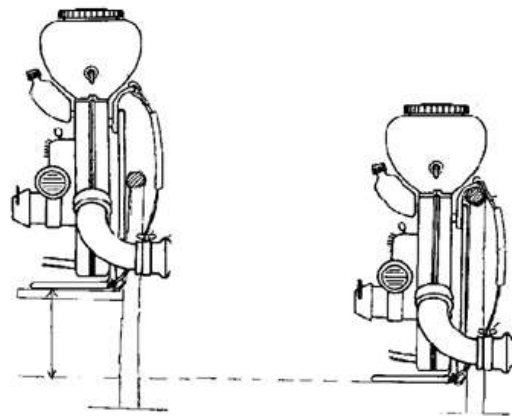

a) Release position

b) Impact position

Figure 11a. Test applied to the load carrying straps

11.2 Test procedure

The straps and their assembly shall withstand the test follows:

- a. The tank shall be filled with clean water to its specified capacity.
- b. The mister cum duster (without discharge line) shall be hung from a solid support by its strap(s) simulating its carriage or to the shoulder of an operator.
- c. Raise the tank vertically to a height of 300 mm and allow to drop freely while hang by the strap (s). Repeat the operation 24 times.
- d. The assembly shall be deemed to have passed this test if none of its parts (straps, brackets, etc) break.

11.3 Report

Record result in the main summary test report

12. Straps absorbance test

12.1 Materials and instrumentation

- a. This test is non-destructive and straps shall be removed from a mister/duster.
- b. A bucket of water
- c. A weighing device

12.2 Test procedure

- a. Any padding, metal or plastic parts attached to the straps are to be removed before immersion (in order to minimize, as far as possible, the dry mass of the straps)
- b. Weigh the straps using a weighing device (m_b)
- c. Completely immerse the straps in water for 2 min.
- d. Remove the straps from the water, shake off surplus liquid and hang freely to drain for 10 min,
- e. Re-weigh straps (m_a)

	Weight (g)
Straps before test (m_b)	
Straps after test (m_a)	

Calculations and criteria:

Variation in mass $\Delta m = 100 \times (m_a - m_b) / m_b$ **max. +30%**



12.3 Report

Report the variation in the test report

13. Blower air velocity

13.1 Materials and instrumentation

- a. This test is non-destructive and operated on a complete mister/duster.
- b. Mount the mister cum duster onto a test bench.

Equipment		
Test bench for mounting mister cum duster	Anemometer	Tachometer
		

13.2 Test procedure

- a. Place the mister cum duster in an operate position. Lock the machine as per position in Figure 13a. Position air duct pipe in a horizontal position such as the height of the mister cum duster outlet center is 1000 ± 20 mm from the ground.
- b. A sampling grid as in figure below prepared by using thin nylon wires, strings or a net on a frame or with a motorized 2D or 3D structure supporting the anemometer.

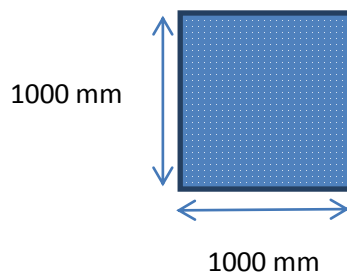

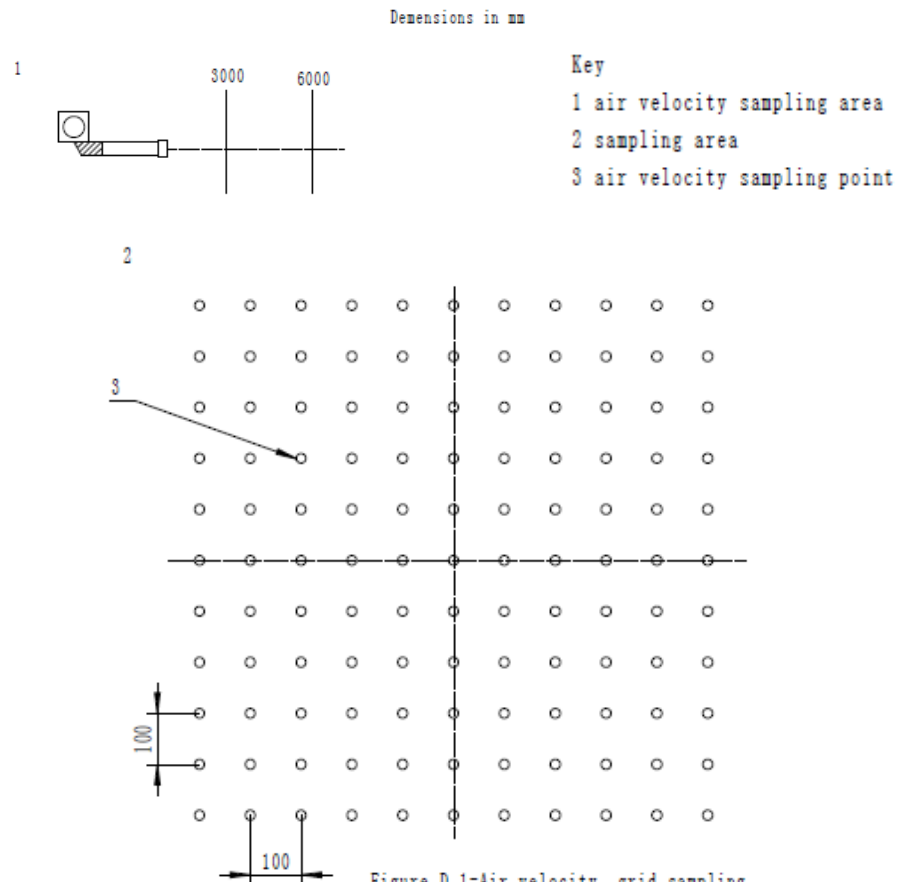

Figure 13a. Air velocity grid sampling

- c. Set the engine speed according to the rated engine speed defined by the manufacturer.
- d. Place an anemometer at the center of the air duct pipe.
- e. Measure the air velocity during 15 seconds at distances of $3\,000 \pm 20$ mm and $6\,000 \pm 20$ mm from the air duct pipe outlet based on sampling grid of 100×100 mm ± 5 mm as per Figure 13a.
- f. Measure at each grid point
- g. Stop measuring when an air velocity lower than 2 m/s is detected.

13.3 Report

Fill in the following tables where the central column and line correspond to the vertical and horizontal axis and the point (0,0) is in the axis of the blower outlet.

Table 13a: Air velocity profile at 3000 ± 20 mm distance

	-500	-400	-300	-200	-100	0	100	200	300	400	500
500											
400											
300											
200											
100											
0											
100											
200											
300											
400											
500											

Table 13b: Air velocity profile at 6000 ± 20 mm distance

	-500	-400	-300	-200	-100	0	100	200	300	400	500
500											
400											
300											
200											
100											
0											
100											
200											
300											
400											
500											

Determination of the effective air volume at 3000 mm:

Consider the area where the air velocity is > 2 m/s (A in m^2) and position its centroid. Calculate the mean value of velocity (V in m/s) along the air velocity profile from the centroid to the mean radius (assuming a linear variation of air velocity along the radius distance).

The effective air volume @ 3000mm = $A \times V$ in $m^3.s^{-1}$

14. Air volume test (ref ANSI/OPEI 172.5 Annex C)

This test consists on the evaluation of the blower capacity estimated through the blow force created by the air flow on a balance's plate.

14.1 Materials and instrumentation

- a. Mount the warmed up mister cum duster on the test bench

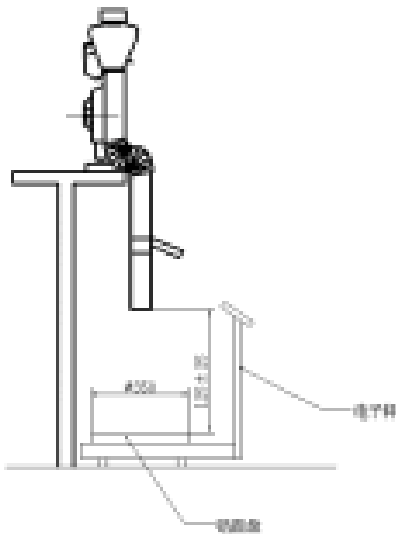

- b. Use a balance (Range 5kg, $e=\pm 10g$) with an aluminium plate of minimum 35 mm

14.2 Test procedure

- a. Position the blower bent pipe vertically at a distance of $125\text{ mm} \pm 25\text{ mm}$ from the plate
- b. Set the Mister cum duster at WOT (wide open throttle) a measure the blow force in N
- c. Repeat the measurement 3 times while returning at idle position between each measurement



14.3 Report

- d. Report the measurements average and sd in the test report
- e. Determine Average velocity, peak velocity and blower air volume according to the ANSI/OPEI 172.5 Annex C

15. Fan over-speed test

15.1 Materials and instrumentation

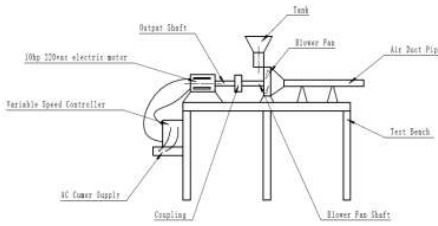
- This test is non-destructive but required the use of a complete mister/duster without engine.
- Attention shall be paid to safety when operating the test
- Mount a unit of the mister cum duster (without engine) onto the overspeed test rig

Equipment	
Test bench for fan overspeed test	Tachometer
  <p>Figure Test rig for over-speed mister/duster test</p>	

15.2 Test procedure



- Mount the test sample (without the engine) onto a test rig with a variable speed controlled electric motor.
- The impeller shall be tested at 1.3 times the rated speed for 5 minutes on the occasion of full load. Check with a tachometer.
- Stop and check that the following phenomena shall not occur to the impeller: get injured, get loose or be out of shape, etc.

- d. Replicate step (b) and step (c) three times.

16. Misting discharge rate (full tank, various tank volumes) and residues

16.1 Materials and instrumentation

- a. This test is non-destructive and required the use of a complete mister.
- b. Weighing device
- c. Mount the machine as shown

Equipment		
Test bench for mounting mister cum duster	Stopwatch	Balance
		

16.2 Test procedure (Full tank)

- a. Fill the tank of the mister with clean water up to its total capacity.
- b. Firmly place the knapsack mister on a weighing scale (or hang it),
- c. Set the flow regulator at a desired setting
- d. The mister should be run idle for some time before commencing the test to avoid initial variation in discharge
- e. Divide the starting and stopping of misting into 5 to 7 segments (stopping is defined as irregular continuous misting).

- f. Measure the time and respective misting rate by weighting the mister between segments. Conduct the horizontal and vertical misting.
- g. Repeat three times.

Calculations and criteria:

$$Q_i = \frac{\Delta g_i}{\Delta t_i}$$

where Q_i = Average discharge rate at measure segment, kg / min

Δg_i = Amount discharged at measured segments, kg

Δt_i = Average time for discharge at measured segments, min

$$Q = \frac{1}{n} \sum_{i=1}^n Q_i$$

where Q = Average discharge rate, kg / min and n = Number of segment

$$S = \sqrt{\left[\frac{1}{n-1} \sum_{i=1}^n (Q_i - Q)^2 \right]}$$

where S = Standard deviation

$$V = \frac{S}{Q} \times 100$$

where V = Coefficient of variation, %

16.3 Report

Report all data in Table 16a

Table 16a. Misting volume, evenness and residue test

Machine model		Rated RPM		Rated power, kW	
Instrument type and model		Environment Temperature/ Humidity		Test date	
Test site	Misting pipe condition: (ex : max discharge rate)				
Inspector					

Test No.	Segment	1	2	3	4	5	6	7	8
	Reduction in test materials (kg)								

Record	Continuous spray time (s)	1								
		2								
		3								
Computation	Continuous spray time (s)	1								
		2								
		3								
		Average								
	Sprayed rate, kg/min									
	Average sprayed rate, kg/min									
	Variation									
	Coefficient of variation (%)									
Residue (kg)										

16.4 Test procedure (intermediate levels of the tank) – maximum discharge rate

- a. Fill the tank with clean water up to one-fourth of its total capacity. Operate the mister at its rated speed and set the flow regulator to maximum discharge. The variation in speed, if any, shall be not more than 5 percent.
- b. Run the engine until the water in tank is emptied. Record the starting and stopping time accurately. Calculate the discharge rate per minute.
- c. Repeat the above test for a minimum of three times and calculate the average discharge rate.
- d. Conduct the above test at one-half and three-fourths of the total capacity of the tank.
- e. The provision for graduations showing 1/4, 1/2, 3/4 and full opening positions shall be made. The data shall be recorded in Table 15b.
- f. The variation in discharge due to tank filling at one-fourth, one-half and three-fourths of total capacity shall not exceed 15 percent of the discharge at total capacity of the tank as obtained in 15.2.

16.5 Report

Table 15b. Misting volume for various tank levels

Machine model		Rated RPM		Rated power, kW	
Instrument type and model		Environment Temperature/ Humidity		Test date	
Test site	Misting pipe condition:				



Inspector					
Test No.	Tank level	1/4	1/2	3/4	
	Reduction in test materials (kg)				
Record	Continuous spray time (s)	1			
		2			
		3			
Computation	Continuous spray time (s)	1			
		2			
		3			
		Average			
	Sprayed rate, kg/min				
	Average sprayed rate, kg/min				
	Variation				
	Coefficient of variation (%)				
Residue (kg)					

17. Dusting discharge rate (full tank, various tank volumes) and residues

17.1 Materials and instrumentation

This test is non-destructive and required the use of a complete duster.

- a. Weigh device
- b. Mount the machine on a test rig
- c. Use a micro granules

Equipment		
Test bench for mounting mister cum duster	Stopwatch	Balance
		

17.2 Test procedure (Full tank)

- a. Fill the tank of the duster with dust/micro granule material up to its total capacity.
- b. Firmly place the knapsack duster on a weighing scale (or hang it),
- c. Set the flow regulator at a desired setting
- d. The duster should be run idle for some time before commencing the test to avoid initial variation in discharge
- e. Divide the starting and stopping of misting into 5 to 7 segments (stopping is defined as irregular continuous misting).

- f. Measure the time and respective dusting rate by weighting the duster between segments. Conduct the horizontal and vertical dusting.
- g. Repeat three times.

Calculations and criteria:

$$Q_i = \frac{\Delta g_i}{\Delta t_i}$$

where Q_i = Average discharge rate at measure segment, kg / min
 Δg_i = Amount discharged at measured segments, kg
 Δt_i = Average time for discharge at measured segments, min

$$Q = \frac{1}{n} \sum_{i=1}^n Q_i$$

where Q = Average discharge rate, kg / min and n = Number of segment

$$S = \sqrt{\left[\frac{1}{n-1} \sum_{i=1}^n (Q_i - Q)^2 \right]}$$

where S = Standard deviation

$$V = \frac{S}{Q} \times 100$$

where V = Coefficient of variation, %

17.3 Report

Report all data in the following Table 17a

Table 17a. Dusting volume, evenness and residue test

Machine model		Rated RPM		Rated power, kW	
Instrument type and model		Environment Temperature/ Humidity		Test date	
Test site	Misting pipe condition:				
Inspector					

Test No.	Segment		1	2	3	4	5	6	7	8
	Reduction in test materials (kg)									
○ ○	Continuous	1								

	dusting time (s)	2								
		3								
Computation	Continuous dusting time (s)	1								
		2								
		3								
		Average								
	Dusting rate, kg/min									
	Average dusting rate, kg/min									
	Variation									
	Coefficient of variation (%)									
	Residue (kg)									

17.4 Test procedure (intermediate levels of the tank – maximum discharge rate)

- a. Fill the tank with dust up to one-fourth of its total capacity. Operate the duster at its rated speed and set the flow regulator to maximum discharge. The variation in speed, if any, shall be not more than 5 percent.
- b. Run the engine until the dust/micro granule in tank is emptied. Record the starting and stopping time accurately. Calculate the discharge rate per minute.
- c. Repeat the above test for a minimum of three times and calculate the average discharge rate.
- d. Conduct the above test at one-half and three-fourths of the total capacity of the tank.
- e. The provision for graduations showing 1/4, 1/2, 3/4 and full opening positions shall be made. The data shall be recorded in Table 16b.
- f. The variation in discharge due "to tank filling at one-fourth, one-half and three-fourths of total capacity shall not exceed 15 percent of the discharge at total capacity of the tank as obtained in 16.2.

17.5 Report

Table 17b. Dusting volume for various tank levels

Machine model		Rated RPM			Rated power, kW	
Instrument type and model		Environment Temperature/ Humidity			Test date	
Test site		Misting pipe condition:				
Inspector						
Test No.	Tank level		1/4	1/2	3/4	
	Reduction in test materials (kg)					
Record	Continuous dusting time (s)	1				
		2				
		3				
Computation	Continuous dusting time (s)	1				
		2				
		3				
		Average				
	Dusting rate, kg/min					
	Average dusting rate, kg/min					
	Variation					
	Coefficient of variation (%)					
Residue (kg)						

18. Misting or dusting range and width during ground deposition test

18.1 Objective

Determine the misting/dusting range and width as in Figure 18a.

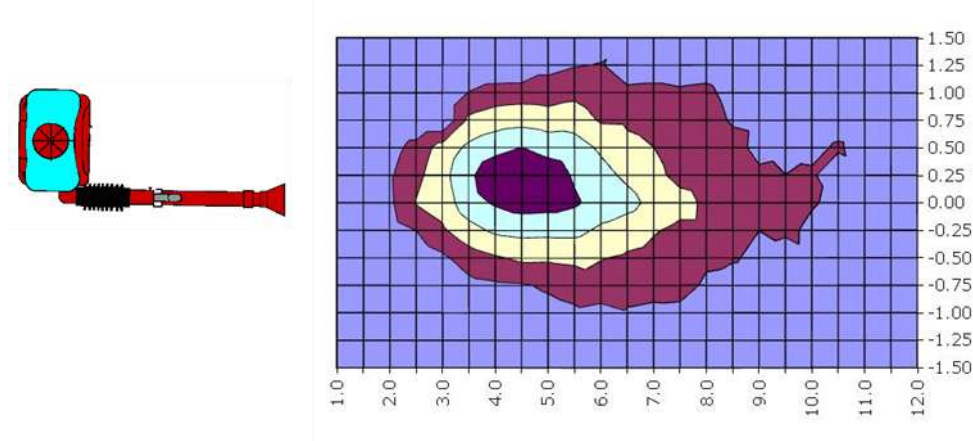



Figure 18a. Misting/Dusting range and width

18.2 Materials and instrumentation

- Conduct this test in an enclosed space without interferences due to wind.
- Place the mister cum duster in an upright position.
- Lock the machine on the test bench.

Equipment
Test bench for mounting mister cum duster

18.3 Test procedure (Full tank)

- a. Position air duct pipe in a horizontal position such as the height of the mister cum duster outlet center is 1000 ± 20 mm from the ground.

Initial trial.

- b. Fill the chemical tank with clean water and set engine at rated speed. Operate the misting at full throttle for 3 min.
- c. Visually observe the coverage of misting that will define the sample zone.

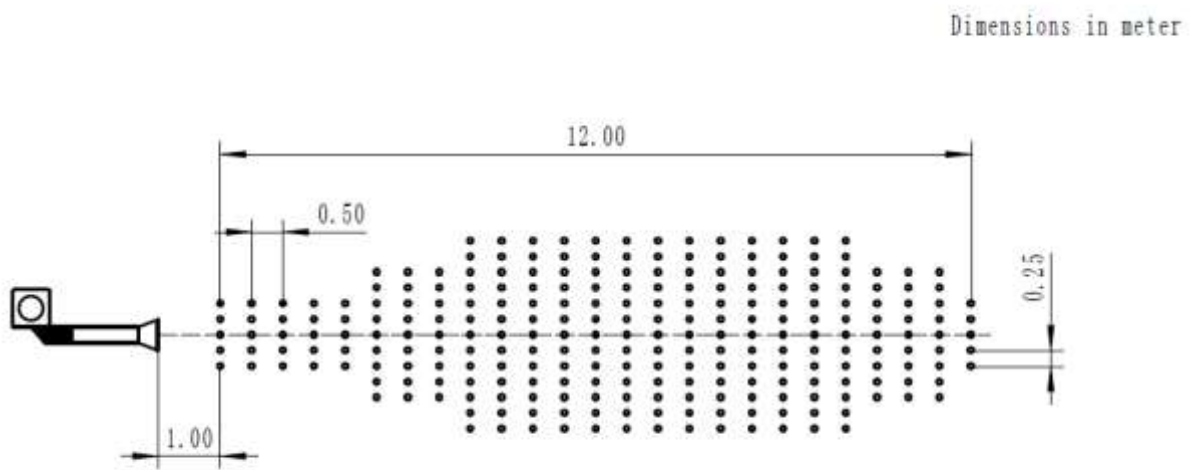

Figure 17b. Sprayer and petri dishes layout

Test preparation

- a. Use rows of 60 mm diameter Petri dishes to sample water droplets. Each sidewall of the indoor enclosure shall have a minimum distance of 500 ± 20 mm from the outermost Petri dishes (Figure 17b).
- b. Weigh and identify each Petri dish. Position the center row of Petri dishes corresponding with the symmetric axis of the air duct pipe. The first Petri dish is placed at 1000 ± 20 mm from the air duct pipe outlet. The following Petri dishes shall be placed at 500 ± 20 mm from one to another. Additional number of Petri dishes is placed as according to the dimension and shape of the zone defined in 17.3 c.
- c. Set the engine speed according to the rated engine speed defined by the manufacturer. This test is conducted with the shutter outlet set at the minimum and the maximum misting/dusting flowrate. Fill the mister tank to the full tank level. Conduct the test until the tank is empty.
- d. Number and collect all Petri dishes and weigh the mass of water taking into

- e. Repeat similar procedure (1 to 4) for dusters considering water is replaced by dust/micro granules.

18.4 Report

Table 18a. Fill in the following tables

	1000	1500	2000	2500	3000	3500	4000	4500	5000	5500	6000...
-2500	Dish1	dish2	dish3	...							
-2000											
-1500											
-1000											
-500											
0											
500											
1000											
1500											
2000											
2500...											

Dish #	Initial mass, g	Mass after misting/dusting, g	Net mass , g
1			
2			
3...			

Report the maximal misting/dusting distance and width.

In case of inadapted atmospheric conditions (ex high temperature & low relative humidity), evaporation process may compromise the protocol if samples are not weighted rapidly. An alternative is possible by using a dye tracer (ex tartrazine) to quantify the deposition by spectrometric or spectrofluorimetric measurements. See ISO 24253 as example).

19. Vertical deposition test (Mister only)

19.1 Materials and instrumentation

- Conduct this test in an enclosed space without interferences due to wind.
- Place the mister cum duster in an upright position.
- Lock the machine as per figure below. Position air duct pipe in a vertical position such as the height of the mister cum duster outlet center is 1000 ± 20 mm from the ground.
- Place a set of sponges tight to the support

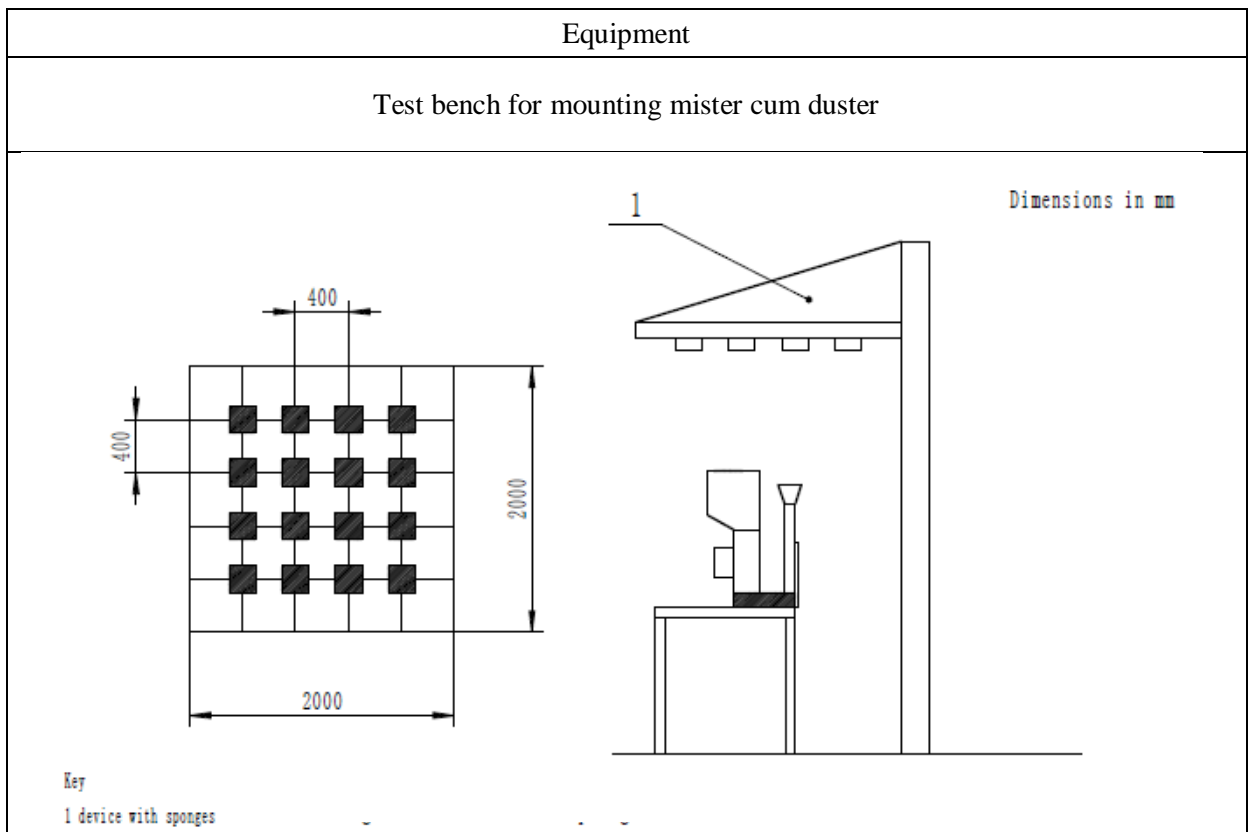

19.2 Test procedure (Full tank)

- A pre-test can be conducted in order to define the sampling area with sponges
- Use rows of sponges to sample water droplets. Identify each sponge, verify it is dry before the test and weigh.

- c. Position the center row of sponges corresponding with the symmetric axis of the air duct pipe. The sponges sampling grid is placed at a height of 3000 ±20 mm from the air duct pipe outlet.
- d. Set the engine speed according to the rated engine speed defined by the manufacturer. This test is conducted with the shutter outlet set at the minimum and the maximum misting flowrate. Fill the mister tank to the full tank level. Conduct the test until the sponges almost get saturated.
- e. Number and collect all sponges and weigh the mass of water taking into consideration the initial mass of each sponge.

19.3 Report

Fill in the following tables

	400	800	1200	1600...
400	Sponge 1	Sponge 2	Sponge 3	Sponge 4
800	Sponge 5	Sponge 6	Sponge 7	Sponge 8
1200	Sponge 9	Sponge 10	Sponge 11	Sponge 12
1600...	Sponge 13	Sponge 14	Sponge 15	Sponge 16

Sponge #	Dry mass (g) DM	Wet mass (g) WM	Water collected (g) W W= WM - DM
1			
2			
3...			

20. Measurement of droplet size and droplet density (Mister only)

20.1 Materials and instrumentation

- a. Conduct this test in an enclosed space without interferences due to wind.
- b. Place the mister cum duster in an upright position.
- c. Position air duct pipe in a horizontal position such as the height of the mister cum duster outlet center is 1000 ± 20 mm from the ground.
- d. Plan scanner
- e. Paper cards or water sensitive papers and Petri dishes.

Equipment
Test bench for mounting mister cum duster

20.2 Test procedure (Full tank)

- a. Fill the tank either with clean water (in case Water Sensitive Papers are used) or coloured water when a dye is used to contrast with artificial collectors such as filter papers, papers cards, etc placed in each Petri dish.
- b. During a short misting time (of about 10s) the duct is moved laterally to avoid collector saturation. All collectors described in the following are analyzed. After digitalization with a

plan scanner, droplet sizes are directly calculated from the impact distribution by using an image analysis software³. At least 3 repetitions of the test are to be achieved.

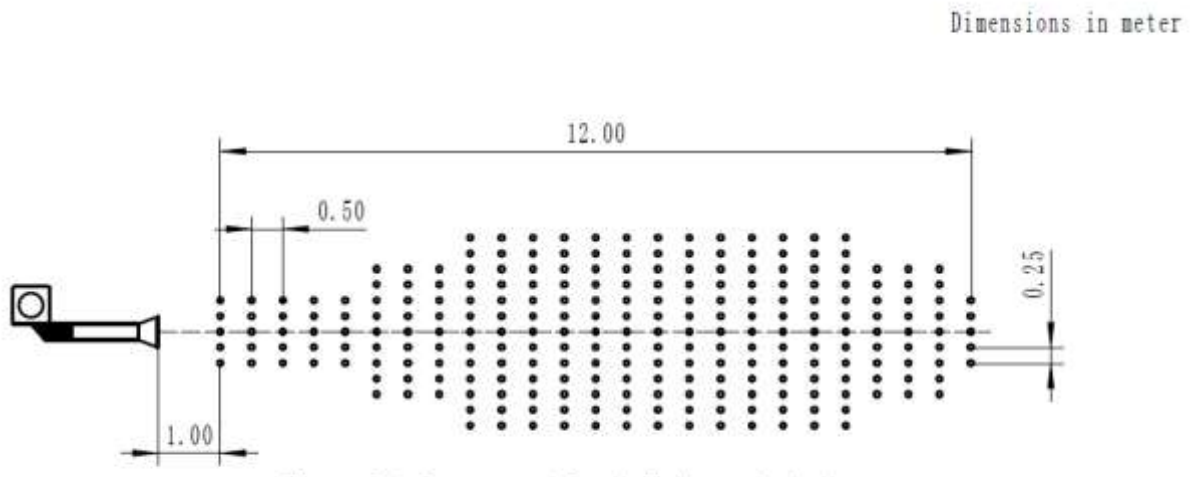

- For each sample image, determine the number of droplets per class of drop size with 10 μm interval.
- Set a table to compile all results
- Calculate the average value for each class and determine the D10, D50 and D90 values.
- D10 : 10 % of impacts have a diameter lower than this value.
- D50 : median value of impact diameter
- D90 : 10 % of impacts have a diameter higher than this value
- % coverage: indicate the average value of coverage

20.3 Data Report

Table 20a. Number of droplets per classes of diameter (μm)

	10	20	30	40	50	60	70	80	90	100	110	120	130	140	150	160	170	180	190	200	
S1																					
S2...																					

Alternative methods :

³ <http://www.ars.usda.gov/services/software/download.htm?softwareid=247>

Droplet sizer devices based on laser diffraction or Phase Doppler Particle size analyzer can alternatively be used.

21. General Noise and ear level noise tests

21.1. Materials and instrumentation

- a. Test equipment set up for ear side noise measurement

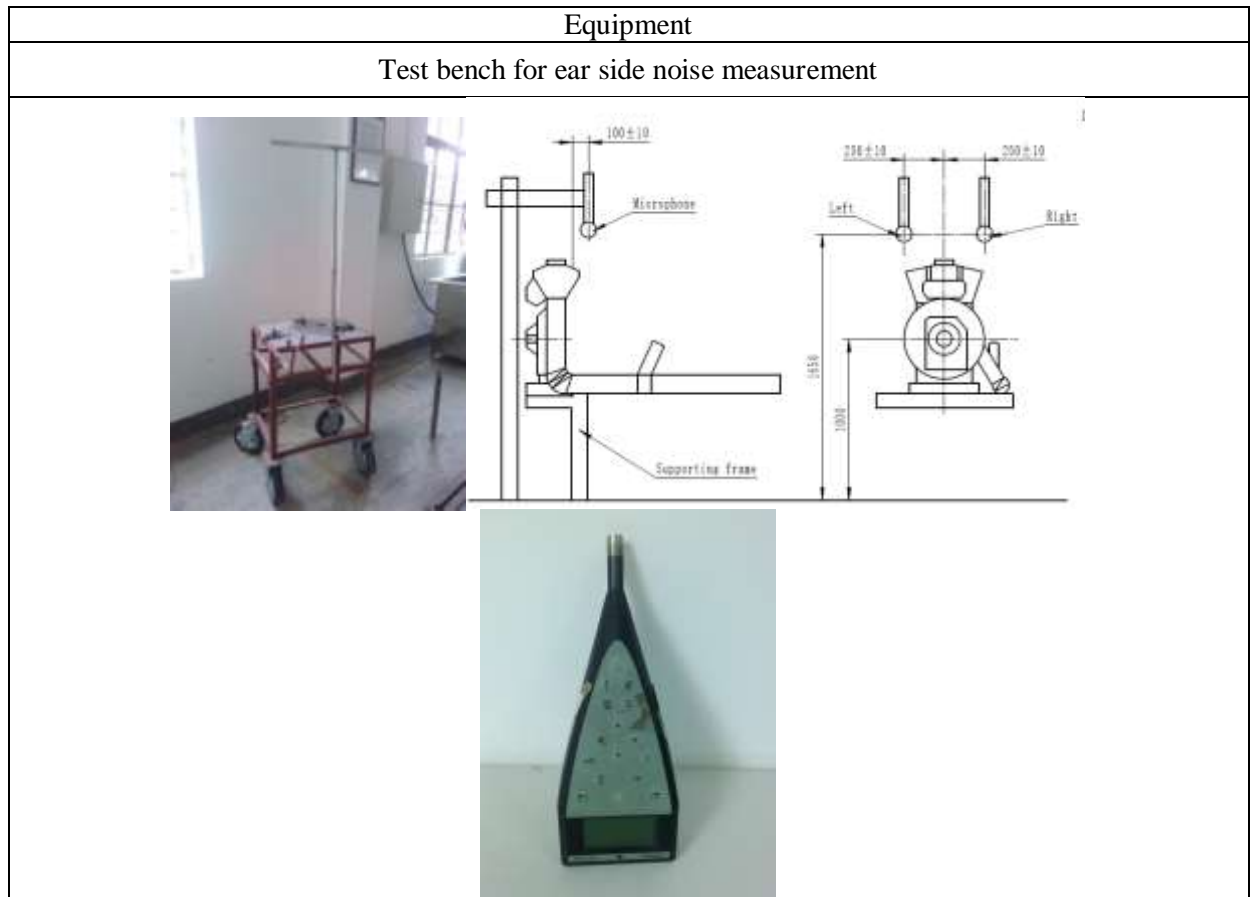

Figure 20a. Setup for noise measurement. (Dimensions are in mm)

21.2 Test procedure

- a. The test of the noise of powered knapsack mister-cum-duster shall be conducted in a flat open field of radius > 20 m.
- b. There shall not be any obstacles or reflective surfaces.
- c. The level of the background noise and the sound pressure level of the wind shall be at least 10 dB (A) below the sound level measured during the test.

- d. The natural wind speed shall be less than 5 m/s otherwise a windbreaker shall be used.
- e. The mister-cum-duster shall be misting normally at its rated speed, at the highest misting rate, and it shall be standing on a stationary platform with the shaft of the engine 1000 mm height above the ground (see figure). The platform shall not resonate or reverberate with the mister-cum-duster.

21.3 Operator ear level noise measurement

- a. During measurement, the microphone is placed vertically left and right at a distance of 250 ± 10 mm, horizontally in front of the operator backpack cushion $100 \text{ mm} \pm 10\text{mm}$ and 1650 mm above the ground level.
- b. Measure the noise level. Repeat 3 times at each point.
- c. Variations between two successive measurements shall not exceed 3 dB(A). Record the max value.
- d. Compute the average, record readings in Table 20a.

Table 21a. Results of noise measurement

	Right	Left	Remarks
Background			
Test 1			
Test 2			
Test 3			

The noise level measured at the ear side shall conform to the specifications as listed in Table 20b.

Table 21b. Noise level limits at ear side, dB (A)

Gasoline engine rated power (kW)	Noise level at various rated engine speed, dB (A)		
	≤ 5500 rpm	$> 5500 - 7000$ rpm	> 7000 rpm
≤ 1.5	≤ 97	≤ 98	≤ 99
$> 1.5 - \leq 2.3$	≤ 99	≤ 100	≤ 101
$> 2.3 - \leq 3.1$	≤ 101	≤ 102	≤ 103

$>3.1 - \leq 3.8$	≤ 103	≤ 104	≤ 105
$>3.8 - \leq 4.5$	≤ 105	≤ 106	≤ 107
>4.5	≤ 107	≤ 108	≤ 109

22. Vibration test

22.1 Materials and instrumentation

- a. Vibrations shall be checked on six (6) to nine (9) locations on the backrest
- b. See section 5, item 5 for instrumentation

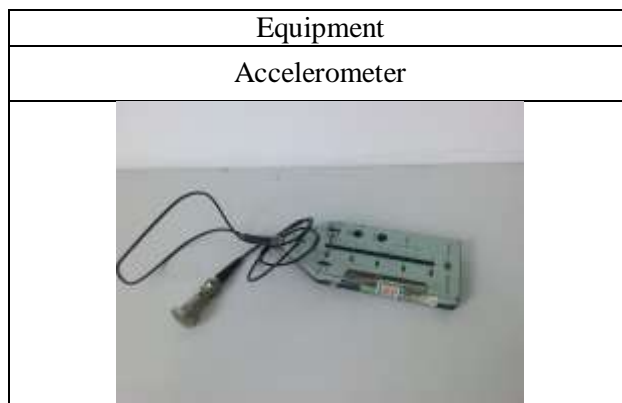

22.2 Test procedure

- a. Fill the chemical tank with ½ tank of clean water.
- b. Fit the knapsack with 6 to 9 metallic pastilles if required for the measurement.
- c. Operate at normal misting conditions.
- d. Repeat the test three times.

22.3 Report

Sensors	1	2	3	4	5	6	7	8	9
Test1									
Test2									
Test3									
Average									

- a. Compute the average record results in the table Annex E-1.
- b. Average vibration acceleration at the back rest shall not exceed 15 m s^{-2} .

23. Reliability and endurance test

23.1 Materials and instrumentation

- Select five (5) misters cum dusters
- Stopwatch

23.2 Test procedure Time to first failure test

Operate the misters cum duster under normal conditions, rated speed at maximum throttle during 100h (example 15 periods of 6 hours).

	Sample 1	Sample 2	Sample 3	Sample 4	Sample 5	
Cycle 1						
Cycle 2						
Cycle 3						
Cycle 4						
Cycle 5						
Cycle 6						
Time of 1 st failure						

Calculation and criteria

$$MTTFF = \frac{1}{n} \left(\sum_{i=1}^r t_i + \sum_{j=1}^{n-r} t_j \right)$$

where: MTTFF = Average operating time before 1st failure, h

n = total number of machines

r = no. of machine having 1st failure (when r =0 hr, n =1)

t_i = Cumulative operating hour of the ith unit of machine first failure

t_j = Cumulative operating hour of the jth machine (not having failure) at the end of 100 hr cumulative operation.

Average operation time to the first failure (exclude minor failure) shall not be less than 50 hrs.

Ex : TFF Sample 1: 58 h; Sample 2: 98 h, Sample 3 to 5 no failure during 100h
n = 5; r = 2; t₁ = 58h; t₂ = 98h; t₃, t₄, t₅ = 100 h

$$MTTFF = 1/5(58+98+300) = 91.2 \text{ h}$$

Note: Minor failure refers to failure which can be easily repaired by farmer such as loose parts, loose wire and unimportant parts.

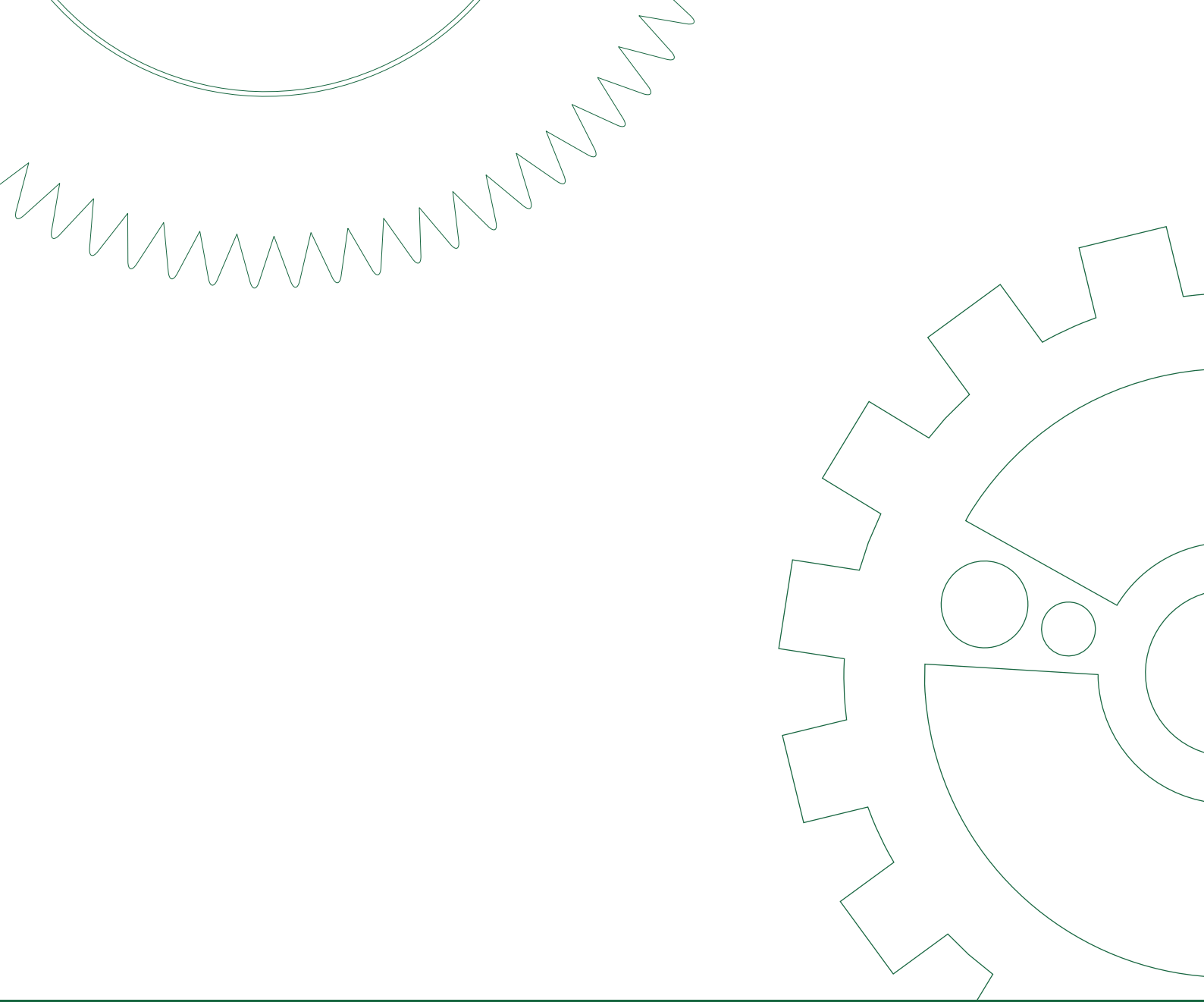

United Nations
Centre for Sustainable Agricultural Mechanization

A-7/F, China International Science and
Technology Convention Centre
No.12, Yumin Road, Chaoyang District
Beijing 100029, P.R.China

Tel: (86-10) 8225 3581
Fax: (86-10) 8225 3584
info@un-csam.org
www.un-csam.org